

2.3 GHz to 2.7 GHz + 3.3 GHz to 4.2 GHz 8-port Sector antenna, 17dBi, 65-degree, 4 x 4 Type N Female Connector, +/- 45 Dual Pol

KP-23SX8-65



Features

- Frequency coverage for 2300 MHz to 2700 MHz and 3300 MHz to 4200 MHz
- Very High Gain 17 dBi to 17.5 dBi Directional Antenna
- Easy Install universal mounting bracket provided
- Weatherproof ABS – UV Resistance PVC radome
- 4x4 MIMO with Type N Female connectors
- 65° beamwidth with dual +/-45 slant polarization
- 100 W max input power

Applications

- 2X2 and 4X4 MIMO ready with dual bands in one shell configuration
- 2.4/3.3/CBRS/sub 5GHz applications supported
- Wireless LAN systems & I25 802.16e applications
- Mobile WiMAX Wireless Internet Provider “cell” site
- Smart cities expansion for coverage and IOT / IIOT
- Outdoor or indoor point-to-point (PtP) or point-to-multipoint (PtMP) applications

Description

KP Performance’s KP-23SX8-65 8-port Sector Antenna provides industry leading gain, side lobes suppression, and high front-to-back ratio. Available in 65° beamwidth with dual +/-45 slant polarization, this antenna works from 2300 MHz to 2700 MHz and 3300 MHz to 4200 MHz with dual band capability in one shell. The KP-23SX8-65 has gain performance of 17 dBi to kkk dBi gain and is perfectly suited for macro base station or small cell deployments.

The KP-23SX8-65 from KP Performance patterns are engineered to be symmetric in both polarizations, which will minimize chain imbalance. The sector antenna’s 25 dB port to port isolation and 25 dB front to back ratio allows for channel (frequency) reuse and can reach high levels of spectral efficiency in the most challenging and noisy environments. The KP-23SX8-65 sector antennas has 8 Type N Female connectors which supports dual band with 2x2 or 4x4 MIMO configurations with 4 ports for 2300 MHz to 2700 MHz and 2x2 or 4x4 MIMO configurations with 4 ports for 3300 MHz to 4200 MHz and multiple combinations of popular radios can be used for high speeds or multiple technology deployments.

The 2.3 GHz to 2.7 GHz and 3.3 GHz to 4.2 GHz KP-23SX8-65 sector antenna with 8 x N-type female connector has rugged and waterproof structure provides durable platform built for a broad range of environments and features a heavy-duty UV-resistance plastic radome for all-weather operation. The powder coated, high strength mounting brackets are built to withstand wind speeds of up to 135 mph and survive in corrosive environments with large swing in seasonal weather not impacting performance of KP performance’s KP-23SX8-65 sector antenna. Our expert technical support and friendly, knowledgeable customer service personnel are available to assist you with your particular needs for high performance sector antennas engineered for superior performance antennas.

Configuration

Design	Sector
Band Type	Dual
Radiation Pattern	Directional
Polarization	45 Deg. Slant
Cable Type	Coax Cable
Connector Type	N Female
Number of Ports	8

Electrical Specifications

Description	Minimum	Typical	Maximum	Units
Frequency Range	2,300		4,200	MHz
Input VSWR		1.7:1	2:1	

Click the following link (or enter part number in “SEARCH” on website) to obtain additional part information including price, inventory and certifications:
[2.3 GHz to 2.7 GHz + 3.3 GHz to 4.2 GHz 8-port Sector antenna, 17dBi, 65-degree, 4 x 4 Type N Female Connector, +/- 45 Dual Pol KP-23SX8-65](#)

2.3 GHz to 2.7 GHz + 3.3 GHz to 4.2 GHz 8-port Sector antenna, 17dBi, 65-degree, 4 x 4 Type N Female Connector, +/- 45 Dual Pol



KP-23SX8-65

Gain	17	17.5	dBi
Front to Back Ratio	25		dB
Horizontal (Azimuth) HPBW	65		Degrees
Vertical (Elevation) HPBW	7		Degrees
Input Power		100	Watts

Specifications by Band

Description	Band 1	Band 2	Band 3	Band 4	Band 5	Units
Range	2.3 to 2.7	3.3 to 4.2				GHz
Gain	17	17.5				dBi
Port to Port Isolation	25	25				dB
Front to Back Ratio	25	25				dB
VSWR Max	2:1	2:1				
Maximum Input Power	100	100				Watts

Mechanical Specifications

Radome Material	PVC
Size	
Length	51.18 in [130 cm]
Width	11.02 in [279.91 mm]
Height	3.14 in [79.76 mm]
Weight	17.637 lbs [8 kg]

Environmental Specifications

Wind Survivability	135 MPH [217.26 KPH]
Wind Loading	

Plotted and Other Data

Notes:

Click the following link (or enter part number in "SEARCH" on website) to obtain additional part information including price, inventory and certifications:
[2.3 GHz to 2.7 GHz + 3.3 GHz to 4.2 GHz 8-port Sector antenna, 17dBi, 65-degree, 4 x 4 Type N Female Connector, +/- 45 Dual Pol KP-23SX8-65](#)

2.3 GHz to 2.7 GHz + 3.3 GHz to 4.2 GHz 8-port
Sector antenna, 17dBi, 65-degree, 4 x 4 Type N
Female Connector, +/- 45 Dual Pol

KP-23SX8-65

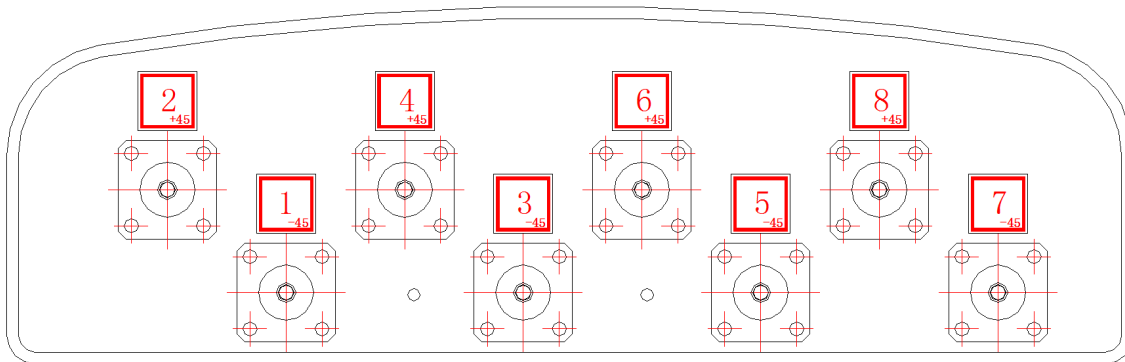

Click the following link (or enter part number in "SEARCH" on website) to obtain additional part information including price, inventory and certifications:
[2.3 GHz to 2.7 GHz + 3.3 GHz to 4.2 GHz 8-port Sector antenna, 17dBi, 65-degree, 4 x 4 Type N Female Connector, +/- 45 Dual Pol KP-23SX8-65](#)

2.3 GHz to 2.7 GHz + 3.3 GHz to 4.2 GHz 8-port Sector antenna, 17dBi, 65-degree, 4 x 4 Type N Female Connector, +/- 45 Dual Pol

KP-23SX8-65

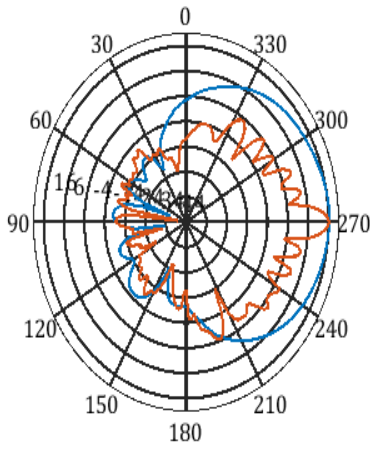

f=2300MHz, Co@2-cuts

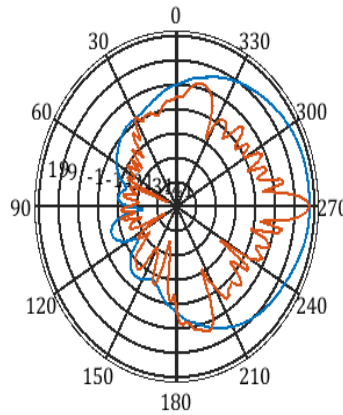

f=2700MHz, Co@2-cuts

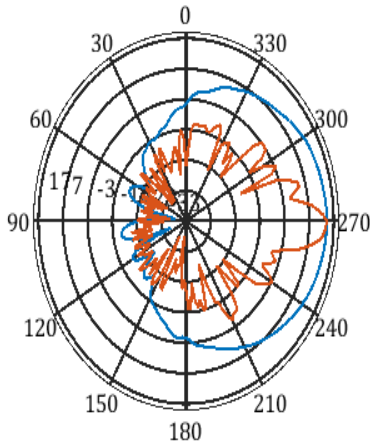

f=3400MHz, Co@2-cuts

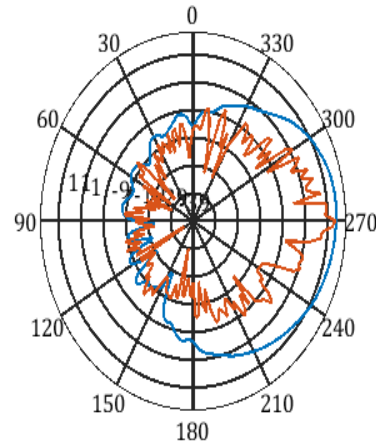

f=4200MHz, Co@2-cuts

Click the following link (or enter part number in "SEARCH" on website) to obtain additional part information including price, inventory and certifications:
[2.3 GHz to 2.7 GHz + 3.3 GHz to 4.2 GHz 8-port Sector antenna, 17dBi, 65-degree, 4 x 4 Type N Female Connector, +/- 45 Dual Pol KP-23SX8-65](#)

2.3 GHz to 2.7 GHz + 3.3 GHz to 4.2 GHz 8-port Sector antenna, 17dBi, 65-degree, 4 x 4 Type N Female Connector, +/- 45 Dual Pol

KP-23SX8-65

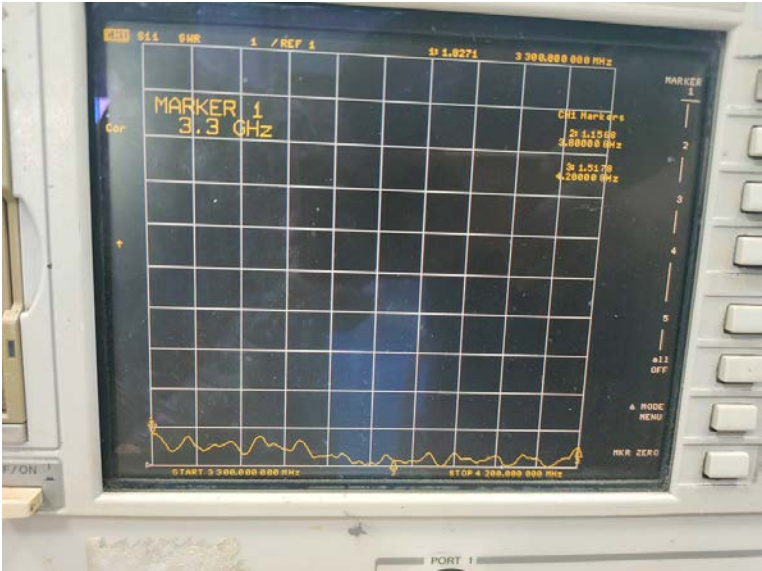
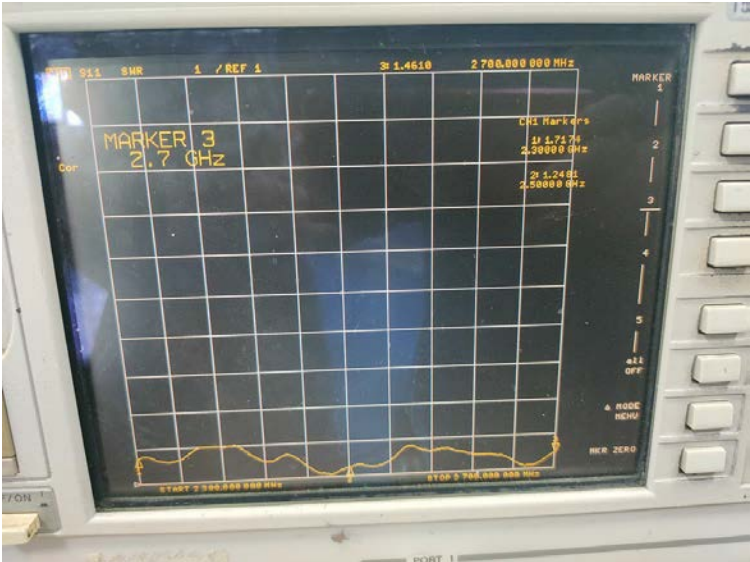

Click the following link (or enter part number in "SEARCH" on website) to obtain additional part information including price, inventory and certifications:
[2.3 GHz to 2.7 GHz + 3.3 GHz to 4.2 GHz 8-port Sector antenna, 17dBi, 65-degree, 4 x 4 Type N Female Connector, +/- 45 Dual Pol KP-23SX8-65](#)

2.3 GHz to 2.7 GHz + 3.3 GHz to 4.2 GHz 8-port
Sector antenna, 17dBi, 65-degree, 4 x 4 Type N
Female Connector, +/- 45 Dual Pol

KP-23SX8-65



Appendix

Electrical Downtilt: Angle in the antenna's elevation pattern in which the maximum gain occurs.

Gain: Antenna's average gain.

Front to Back Ratio @ 180°±30°: Average difference between the antenna's maximum gain and the maximum gain in the antenna's back lobe over ±30° angles.

Cross-polarization Ratio (dB): Typical difference between the co-polarization and cross-polarization gain across the sector's 3 dB Beam Width.

Dedicated to serving the needs of the Wireless Internet Service Provider (WISP) market, KP Performance Antennas offers purpose built products that reliably perform in the field. KP Performance Antennas product line consists of Yagi, Grid, Omni, Dish and other style antennas that operate in the 900 MHz, 2.4 GHz, 3 GHz, and 5 GHz frequencies.

Click the following link (or enter part number in "SEARCH" on website) to obtain additional part information including price, inventory and certifications: [2.3 GHz to 2.7 GHz + 3.3 GHz to 4.2 GHz 8-port Sector antenna, 17dBi, 65-degree, 4 x 4 Type N Female Connector, +/- 45 Dual Pol KP-23SX8-65](#)

URL:

The information contained within this document is accurate to the best of our knowledge and representative of the part described herein. It may be necessary to make modifications to the part and/or the documentation of the part in order to implement improvements. KP Performance reserves the right to make such changes as required. Unless otherwise stated, all specifications are nominal. KP Performance does not make any representation or warranty regarding the suitability of the part described herein for any particular purpose, and KP Performance does not assume liability arising out of the use of any part or document.

2.3 GHz to 2.7 GHz + 3.3 GHz to 4.2 GHz 8-port Sector antenna, 17dBi,
65-degree, 4 x 4 Type N Female Connector, +/- 45 Dual Pol

KP-23SX8-65 CAD Drawing

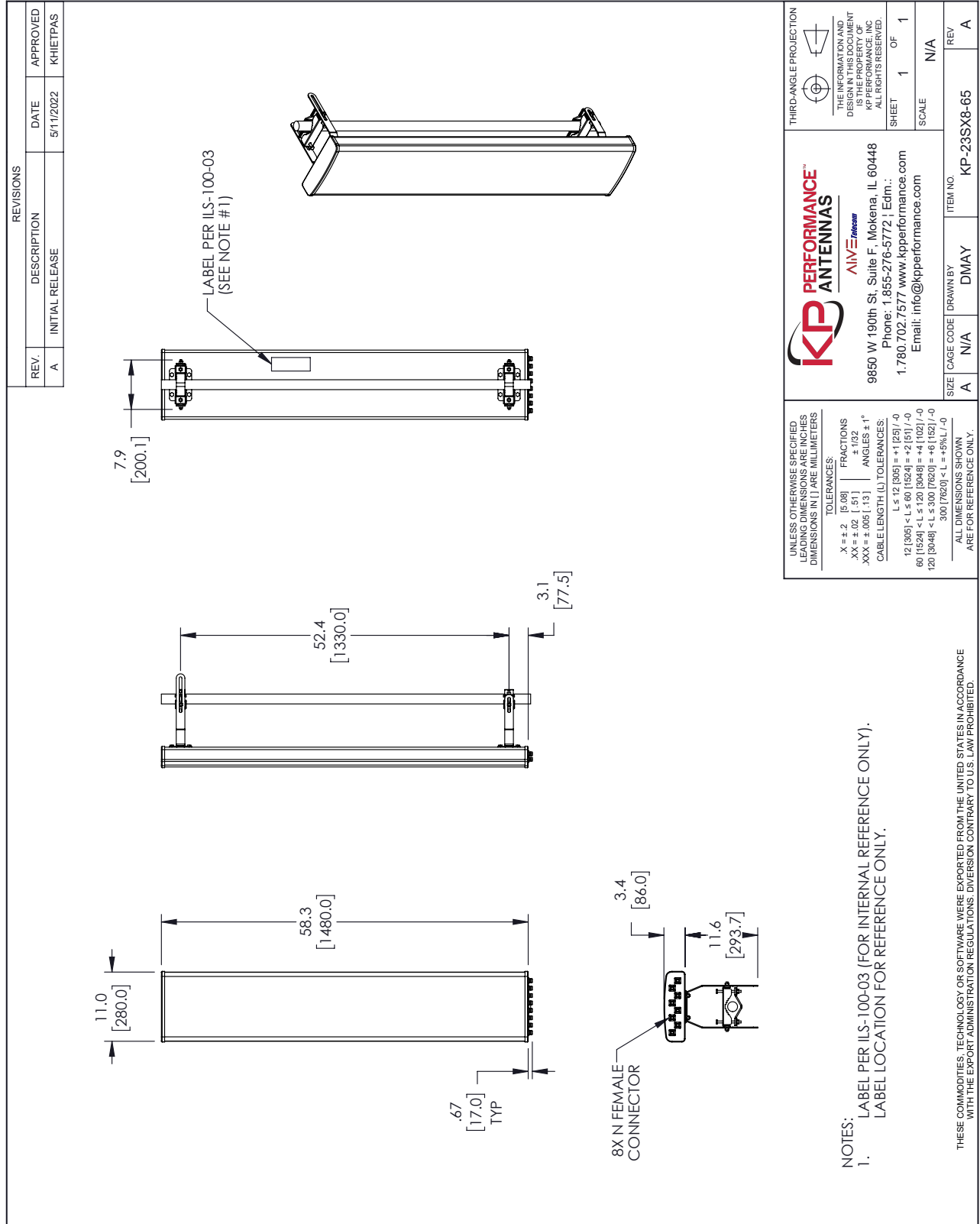

KP PERFORMANCE™
ANTENNAS

ALIVE TELECOM

9850 W 190th St, Suite F, Mokena, IL 60448
Phone: 1.855-276-5772 | Edm.:
1.780.702.7577 www.kpperformance.com
Email: info@kpperformance.com

SIZE A CAGE CODE N/A DRAWN BY DMAY ITEM NO. KP-23SX8-65